

# Exclusive Window Collection.

Enhancing The Beauty And Value Of Your Home.

| Series 1000 | Series 4000/5000 | Series 4000/5000 Hybrid |



**QUALITY WINDOWS & DOORS**  
GREAT SERVICE. EXCEPTIONAL VALUE.

[northstarwindows.com](http://northstarwindows.com)



Since 1985 North Star has been an industry leader in the manufacture of attractive and energy-efficient vinyl windows and patio doors. Whether you're building a new home or upgrading to today's standards, North Star has an extensive range of quality, energy-efficient, and full-featured windows that are not only beautiful, but offer exceptional value.







**Stainable and Paintable Interior Finish** – Match the custom look of existing interior wood finishes with North Star's unique stainable or paintable interior overlays with wood grain texture. Our new screen design can also be laminated with the same material allowing it to be color matched to the window frame.

## Why We Are The Best

**North Star has earned a reputation for manufacturing and distributing attractive, high-quality, energy efficient vinyl windows and doors.**

North Star's manufacturing system ensures all our vinyl windows and doors are built to meet or exceed industry standards. Our products are tested and certified by Energy Star and comply with American Architectural Manufacturers Association (AAMA) standards. We're so confident in our windows and doors that we back them with a transferable, limited lifetime warranty.

When you buy North Star products, you know you're getting the best quality and value for your investment.





### Grilles

The beauty of your North Star windows can be enhanced through traditional or contemporary grilles, available in three profiles: 1/4" square, 5/8" flat and 3/4" contour.



1/4" SQUARE



5/8" FLAT



3/4" CONTOUR

### Grille Configurations:

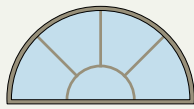

CUSTOM & ARCHITECTURAL

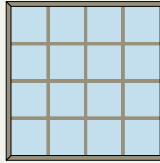

REGULAR SQUARES

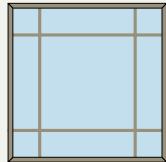

PRAIRIE

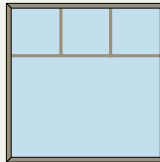

MUSKOKA

### Grille Types



BETWEEN THE GLASS

#### Between The Glass (BTG) –

Our BTG grilles are encased between the two panes of insulating glass, leaving a smooth surface that's a breeze to clean.

Grilles between the glass are available in white, pewter, brass and in colors to match the interior and exterior finishes of our windows and doors.

#### Simulated Divided Lites (SDL) –



SIMULATED DIVIDED LITES

Our SDL grilles look like traditional divided lite grilles, but offer the outstanding performance of our energy-efficient windows. SDL grilles

are applied to the outer surfaces of the insulated glass for a more traditional profile – inside and out. Exterior grilles are available in colors to match our exterior color options, while interior grilles come in white, kolonial oak or stainable/paintable overlays.

For details on the color and profile combinations available, visit our website, [northstarwindows.com](http://northstarwindows.com)

### Colors

North Star AAMA-certified extrusions are available in white and seven standard exterior laminated colors - espresso, sable, chestnut brown, cocoa, sandalwood, hickory and ivory. These UV-resistant vinyl overlays, with an embossed wood grain texture, will remain attractive for years to come.

You can also enjoy the warmth of an oak interior finish with our kolonial oak acrylic overlay, virtually indistinguishable from real wood. If matching to pre-existing wood stains or paint colors, use our stainable or paintable overlay with its wood grain texture.

*The all vinyl 4000/5000 series is only available in white for both interior and exterior surfaces.*

### Vinyl - 1000 Series

Exterior Colors



WHITE



HICKORY



IVORY



CHESTNUT BROWN



SABLE



ESPRESSO



COCOA



SANDALWOOD

### Aluminum/ Vinyl - Hybrid



WHITE



TAN SAND



SLATE



CHARCOAL



BLACK

Interior Finishes



WHITE



STAINABLE/PAINTABLE



KOLONIAL OAK



WHITE

**When you purchase North Star windows and doors, you get a high-quality and low-maintenance product with a limited lifetime warranty.**

Made of durable vinyl, they never need to be painted. And because they exceed industry standards for energy efficiency, they are proven to reduce your energy costs while they increase the value of your home.



### **Awning Windows**

Awning windows improve airflow, and protect your home from the elements, making them an excellent solution for basements, near walkways or above doors and other windows for increased ventilation and light.



### **Casement Windows**

Casement windows offer contemporary styling and convenience. They open and close easily with the simple turn of a handle, and provide clean sightlines with an unobstructed view. Durable multi-point locking hardware comes standard.



### **Picture Windows**

Available in extrusions that match all of our operating windows, the picture window's simplicity makes it the most versatile of our line. They can be combined in a series of fixed and operable windows to enhance your décor – and your view.



**Contoured Glazing Stop** – Interior contoured glazing stop with miter-cut corners for clean lines that complement any room.



**Exterior Bevelled Frames** – Attractive exterior frames feature a traditional looking bevelled profile.



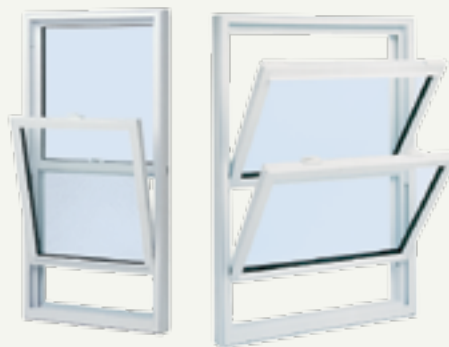

### Horizontal Slider Windows

Offering a large, unobstructed view, our sliders operate with finger-tip ease. Sashes of our single and double lift sliders and three-lite end vent sliders lift out for cleaning, while double tilt slider windows tilt in for easy roomside cleaning.

### Single- & Double-Hung Windows

Single- and double-hung tilt windows deliver traditional beauty with improved security, lower maintenance and increased energy efficiency. Featuring cam locks and recessed finger latches, the sashes slide and tilt in for easy, safe cleaning.

### Bow Windows

Almost any opening can become an instant greenhouse or relaxing nook with a striking bow window. Comprised of any combination of four to five individual windows, both insulated and non-insulated head and seat options are available.



**Triple Weatherstripping** – Provides long lasting protection against water and air infiltration in our casement and awning windows.



**Self-Locking Latch** – Optional self-locking hardware, available on the single- or double-hung and slider, provides homeowners even greater security and peace of mind.

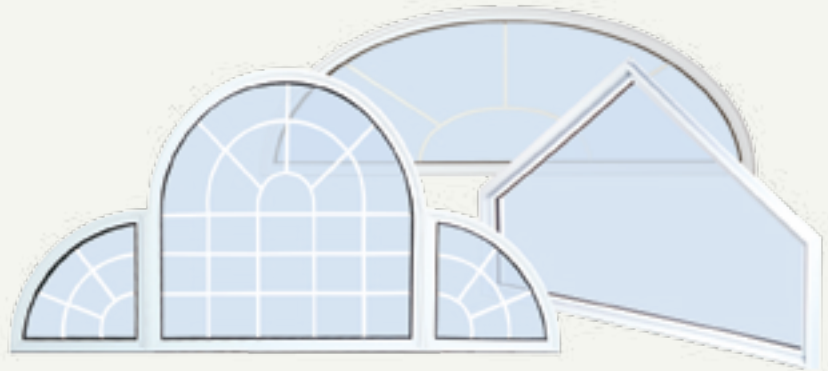

### Bay Windows

Few styles outshine the bay for beautifying a home's exterior and flooding natural light into interior spaces. Projecting outward from a wall at 30 or 45 degree angles to create a cozy alcove, any combination of windows can be used to create a beautiful bay window. Head and seat options can be insulated or non-insulated.

### Custom Shape Windows

Make your house not only a home but a work of art by adding custom shape picture or single-hung windows. Designed just for you to enhance the style and architectural detailing of your home, custom shapes add a unique artistic element to your living space.

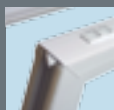

**Recessed Finger Latch** – A simple, concealed latching system that is easy to operate, yet offers superior security.



**Screen Pulls** – Durable pull tabs take the struggle out of removing window screens. These tabs are available in colors that match North Star's windows.

## Standard Features For All Of Our Energy-Efficient Quality Windows

- 1. Super Spacer®** – The Quanex Premium Super Spacer between glass panes resists condensation, reduces noise and boosts insulation values by up to 30%.
- 2. Energy Advantage™ Low-E** – Energy Advantage Low-E is a high performance, energy-efficient glass made with a coating that is designed for top performance in our northern climate, which is why it can rate highest on the Canadian Energy Rating. Energy Advantage Low-E glass allows the sun's energy to warm your home in the winter. Other low-e glass options, designed to minimize cooling costs, are also available.
- 3. Fusion Welded** – The corners on all North Star frames and sashes are fusion welded for added strength and a perfect seal.
- 4. Energy Efficient Extrusions** – North Star's multi-chambered vinyl extrusions save energy – and money – and resist warping, cracking and peeling.

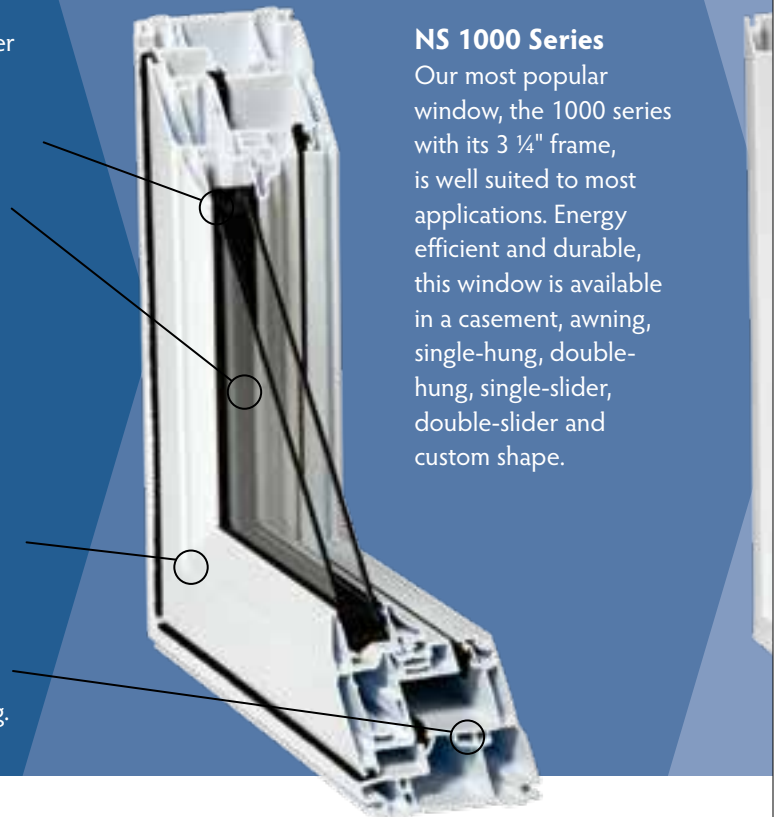

### NS 1000 Series

Our most popular window, the 1000 series with its 3 1/4" frame, is well suited to most applications. Energy efficient and durable, this window is available in a casement, awning, single-hung, double-hung, single-slider, double-slider and custom shape.

### Hardware

Hardware and locks used in North Star's windows are easy to use, secure and come with a lifetime warranty. Durable multi-point locking hardware comes standard with all casement windows.

### Fold-Down Handles

Optional fold-down handles on our casement windows lie flatter than traditional handles and allow window treatments to close neatly.



### Glass

To increase the efficiency of our windows and doors, North Star uses energy-saving Low-E glass that features a near-invisible coating that reduces the amount of heat lost while letting in light.

And the Super Spacer® technology in every window we make resists condensation, boosts R-values and reduces noise.

Optional self-cleaning glass features a unique treatment that allows the glass to break down organic dirt that collects on the surface. Dirt washes away with the next rain.

Pilkington Activ™ Self-Cleaning Glass is available in every North Star window.

Other glass options include

- Argon and Krypton gas filled
- Tempered glass
- Bronze- and gray-tint glass
- Triple glazing
- Obscure glass



**Triple Glazing** – For unparalleled performance and superior energy efficiency ask for North Star's triple insulated glass unit.





**NS 4000 Series/  
NS 5000 Series**

Available in two widths, our 4 ½" and 5 ¼" full frame window, positions the insulated glass unit on the warm side of the building envelope, for reduced condensation and greater comfort. Available in a casement, awning, single-hung, single-slider and custom shape.

*Available in white only.*

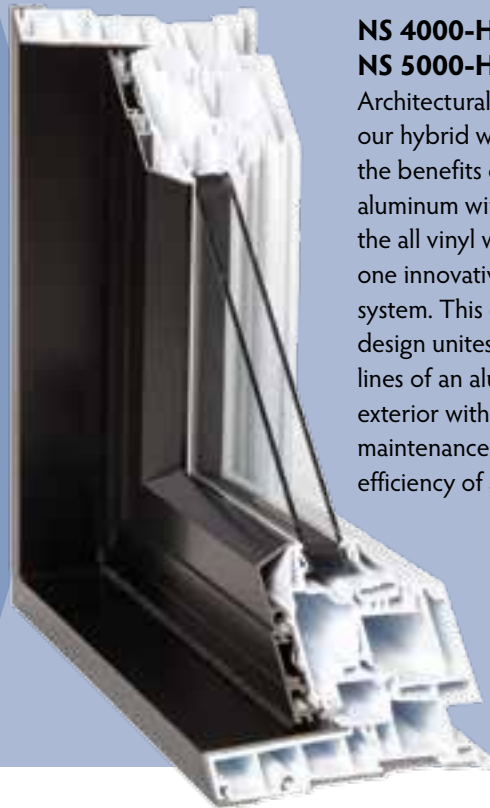

**NS 4000-H (Hybrid) /  
NS 5000-H (Hybrid)**

Architecturally inspired, our hybrid window offers the benefits of both the aluminum window and the all vinyl window in one innovative window system. This durable design unites the clean lines of an aluminum exterior with the easy maintenance and energy efficiency of a vinyl interior.

**Accessories**

North Star offers a range of accessory options, including wood or vinyl jamb extensions that make a seamless transition from the window frame to your interior finish. Exterior accessories include brickmould with built in siding J-channel and nail fins for ease of installation and a weather-tight seal to the outdoors. For a refined architectural look, add our 2" brickmould with cap. A 2" x ½" extrusion is also available that can be used as either a sill extension or a brickmould giving our 1000 series a more contemporary look.

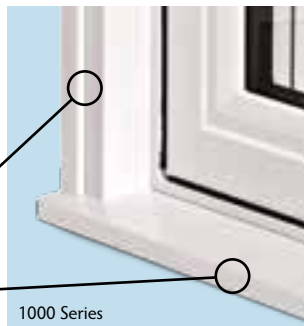

**Brickmould With Cap**

**Exterior Extension**

**EZ-Screen**

North Star's innovative EZ-Screen comes standard in all Casement and Awning windows. Featuring a completely hidden retention system, EZ-Screen has smooth edges that won't snag on draperies and is incredibly easy to use – just push-down and pull-out!



**For more information on accessories for all of the window series, please visit our website, [northstarwindows.com](http://northstarwindows.com)**



## Manufactured To The Highest Standards

The strong relationship we have with our various manufacturing partners has helped us maintain our reputation for leadership, innovation and the production of windows and doors of impeccable quality.



[northstarwindows.com](http://northstarwindows.com)